



Clock Generator for AMD™ Hammer

Features

- Supports AMD™ Hammer CPU
- Two differential pairs of CPU clocks
- Eight low-skew/low-jitter PCI clocks
- One free-running PCI clock
- Four low-skew/low-jitter PCI/HyperTransport™ clocks
- One 48M output for USB
- One programmable 24M or 48M for FDC
- Three REF 14.318-MHz clocks
- Dial-a-Frequency® programmability
- Lexmark Spread Spectrum for optimal electromagnetic interference (EMI) reduction
- SMBus register-programmable options
- 5V-tolerance SCLK and SDATA lines
- 3.3V operation
- Power management control pins
- 48-pin SSOP package

Table 1. Frequency Table (MHz)^[1]

FS (3:0)	PCI HT SEL	CPU	HT66	PCI
0000	X	High-Z (All outputs except XOUT are three-stated)		
0001	0/1	133.9	67.0/33.5	33.5
0010	0/1	166.9	66.8/33.4	33.4
0011	0/1	200.9	67.0/33.5	33.5
0100	0/1	100.0	66.7/33.3	33.3
0101	0/1	133.3	66.7/33.3	33.3
0110	0/1	166.7	66.7/33.3	33.3
0111 (default)	0/1	200.0	66.7/33.3	33.3
1000	0/1	105.0	70.0/35.0	35.0
1001	0/1	110.0	73.3/36.7	36.7
1010	0/1	210.0	70.0/35.0	35.0
1011	0/1	240.0	60.0/30.0	30.0
1100	0/1	270.0	67.5/33.8	33.8
1101	0/1	233.3	58.3/29.2	29.2
1110	0/1	266.7	66.7/33.3	33.3
1111	0/1	300.0	75.0/37.5	37.5

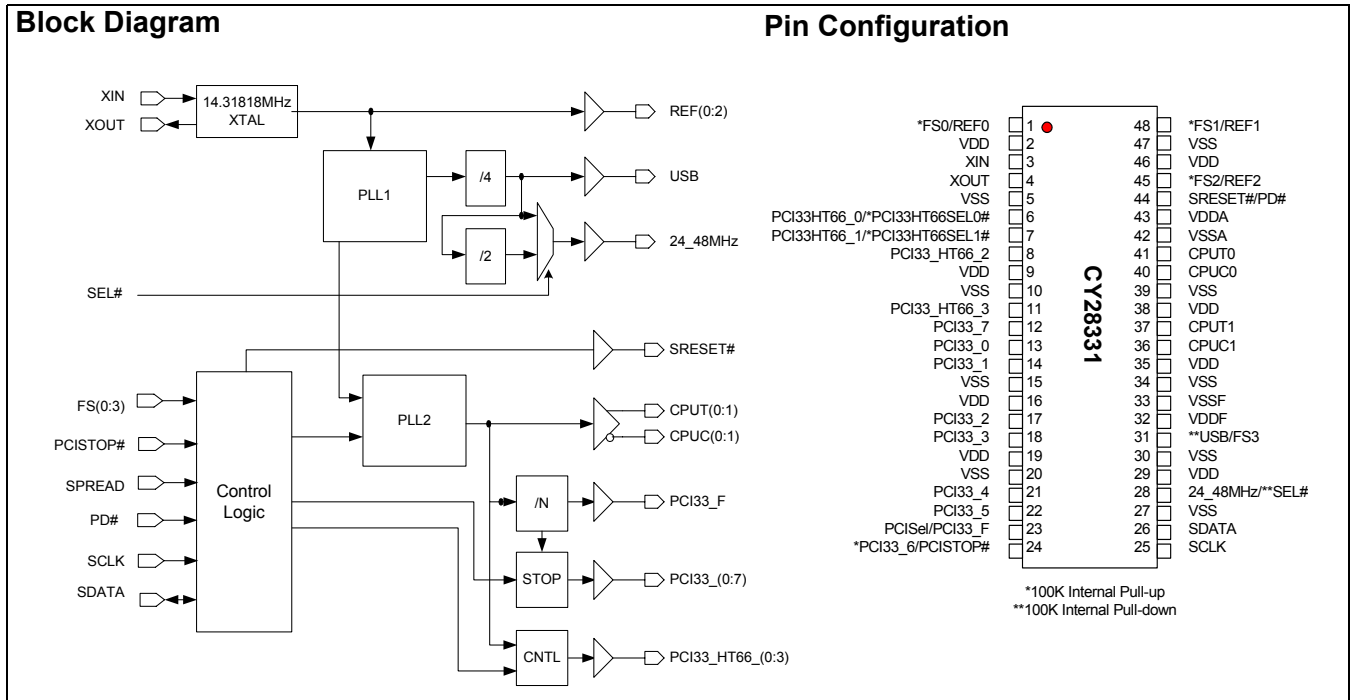

Note:
1. HCLK, 66 MHz, and 33 MHz are in phase and synchronous at power-up.

Pin Description

Pin	Name	PWR	I/O	Description																														
3	XIN	V _{DD}	I	Oscillator Buffer Input. Connect to a crystal or to an external clock.																														
4	XOUT	V _{DD}	O	Oscillator Buffer Output. Connect to a crystal. Do not connect when an external clock is applied at XIN.																														
41, 37	CPUT(0:1)	V _{DCC}	O	CPU clock outputs 0 and 1: push-pull “true” output of differential pair.																														
40, 36	CPUC(0:1)	V _{DCC}	O	CPU clock outputs 0 and 1: push-pull “complement” output of differential pair.																														
13, 14, 17, 18, 21, 22	PCI33(0:5)		O	3.3V PCI clock outputs controlled by PCISTOP#.																														
23	PCISel / PCI33_F		I/O	PCISel is a strap option during power-up to select Pin 24 functionality: 0: Configure Pin 24 as PCI33_6 1: Configure Pin 24 as PCISTOP# (default 100k internal pull-up) After power-up, this pin reverts to standard PCI33_F output.																														
8, 11	PCI33_HT66(2:3)	V _{DDD}	O	3.3V PCI 33-MHz or HyperTransport 66 clock outputs. This group is selectable between 33 MHz and 66 MHz, based on the state of PCI33HT66SEL[0:1]#.																														
6, 7	PCI33_HT66_[0:1]/ PCI33_HT66SEL[0:1]#	V _{DDD}	I/O	PCI33 or HT66 select. This input strap selects the output frequency of PCI33_HT66 outputs to either 33 MHz or 66 MHz. There is an internal 100Kohm pull-up resistor. After power-up, this pin becomes PCI33_HT66_[0:1] output. <table border="0" style="font-size: small;"> <tr> <td>SEL1</td> <td>SEL0</td> <td>PIN6</td> <td>PIN7</td> <td>PIN8</td> <td>PIN11</td> </tr> <tr> <td>0</td> <td>0</td> <td>HT66_0</td> <td>HT66_1</td> <td>HT66_2</td> <td>HT66_3</td> </tr> <tr> <td>0</td> <td>1</td> <td>HT66_0</td> <td>HT66_1</td> <td>HT66_2</td> <td>PCI33_3</td> </tr> <tr> <td>1</td> <td>0</td> <td>HT66_0</td> <td>HT66_1</td> <td>PCI33_2</td> <td>PCI33_3</td> </tr> <tr> <td>1</td> <td>1</td> <td>HT66_0</td> <td>PCI33_1</td> <td>PCI33_2</td> <td>PCI33_3</td> </tr> </table>	SEL1	SEL0	PIN6	PIN7	PIN8	PIN11	0	0	HT66_0	HT66_1	HT66_2	HT66_3	0	1	HT66_0	HT66_1	HT66_2	PCI33_3	1	0	HT66_0	HT66_1	PCI33_2	PCI33_3	1	1	HT66_0	PCI33_1	PCI33_2	PCI33_3
SEL1	SEL0	PIN6	PIN7	PIN8	PIN11																													
0	0	HT66_0	HT66_1	HT66_2	HT66_3																													
0	1	HT66_0	HT66_1	HT66_2	PCI33_3																													
1	0	HT66_0	HT66_1	PCI33_2	PCI33_3																													
1	1	HT66_0	PCI33_1	PCI33_2	PCI33_3																													
31	USB/FS3		I/O	3.3V USB clock output at 48 MHz. At power-up this pin is sensed to determine the CPU output frequency. There is an internal 100K-ohm pull-down resistor.																														
28	24_48MHz/SEL#		I/O	3.3V super I/O clock output. At power-up this pin is sensed to determine whether the output is 24 MHz or 48 MHz. There is an internal 100K-ohm pull-down resistor. This pin will be externally strapped high using a 10K-ohm resistor to V _{SS} . 0 = 48 MHz, 1 = 24 MHz.																														
1, 48, 45	REF(0:2)/FS(0:2)		I/O	3.3V reference clock output. At power-up this pin is sensed to determine the CPU output frequency. There is an internal 100K-ohm pull-up resistor for FS0, while FS(1:2) includes 100K ohm pull-up resistors.																														
44	SRESET#/PD#		I/O	Watchdog Time-out Reset Output. Power-down input (100K internal pull-up).																														
24	PCI33_6/ PCISTOP#		I/O	When configured through pin 23 as PCI_STOP#, this pin controls the PCI33(0:5,7) and PCI33_HT66(1:3) outputs. Active LOW control input to halt all 33-MHz PCI clocks except PCI33_F. Only the PCI33_HT66 outputs that are running at 33 MHz will be stopped. The outputs will be glitch-free when turning off and turning on (100K internal pull-up). When configured through pin 23 as PCI33_6, PCI_STOP# is unavailable.																														
12	PCI33_7		O	3.3V PCI clock outputs controlled by PCISTOP#.																														
26	SDATA		I/O	Data pin for SMBus (rev2.0). There is an internal 100K-ohm pull-up resistor.																														
25	SCLK		I	Clock pin for SMBus (rev2.0). There is an internal 100K-ohm pull-up resistor.																														
2, 9, 16, 19, 29, 35, 38, 46	V _{DD}		PWR	Power connection to 3.3V for the core.																														
5, 10, 15, 20, 27, 30, 34, 39, 47	V _{SS}		GND	Power connection to GROUND for the CORE section of the chip.																														
43	V _{DDA}		PWR	Power connection to 3.3V for the ANALOG section of the chip.																														

Pin Description (continued)

Pin	Name	PWR	I/O	Description
42	V _{SSA}		GND	Power connection to GROUND for the analog section of the chip.
32	V _{DDF}		PWR	Power connection to 3.3V for the 48-MHz PLL section of the chip.
33	V _{SSF}		GND	Power connection to GROUND for the 48-MHz PLL section of the chip.

Serial Data Interface

To enhance the flexibility and function of the clock synthesizer, a two-signal serial interface is provided. Through the Serial Data Interface (SDI), various device functions, such as individual clock output buffers, can be individually enabled or disabled. The registers associated with the SDI initialize to their default setting upon power-up, and therefore use of this interface is optional. Clock device register changes are normally made upon system initialization, if any are required. The interface can also be used during system operation for power management functions.

Data Protocol

The clock driver serial protocol accepts byte write, byte read, block write, and block read operations from the controller. For block write/read operation, the bytes must be accessed in sequential order from lowest to highest byte (most significant bit first) with the ability to stop after any complete byte has been transferred. For byte write and byte read operations, the system controller can access individually indexed bytes. The offset of the indexed byte is encoded in the command code, as described in *Table 2*.

The block write and block read protocol is outlined in *Table 3* while *Table 4* outlines the corresponding byte write and byte read protocol. The slave receiver address is 11010010 (D2h).

Table 2. Command Code Definition

Bit	Description
7	0 = Block read or block write operation, 1 = Byte read or byte write operation.
(6:0)	Byte offset for byte read or byte write operation. For block read or block write operations, these bits should be '0000000.'

Table 3. Block Read and Block Write Protocol

Block Write Protocol		Block Read Protocol	
Bit	Description	Bit	Description
1	Start	1	Start
2:8	Slave address – 7 bits	2:8	Slave address – 7 bits
9	Write = 0	9	Write = 0
10	Acknowledge from slave	10	Acknowledge from slave
11:18	Command Code – 8 bits '00000000' stands for block operation	11:18	Command Code – 8 bits '00000000' stands for block operation
19	Acknowledge from slave	19	Acknowledge from slave
20:27	Byte Count – 8 bits	20	Repeat start
28	Acknowledge from slave	21:27	Slave address – 7 bits
29:36	Data byte 1 – 8 bits	28	Read = 1
37	Acknowledge from slave	29	Acknowledge from slave
38:45	Data byte 2 – 8 bits	30:37	Byte count from slave – 8 bits
46	Acknowledge from slave	38	Acknowledge
....	39:46	Data byte from slave – 8 bits
....	Data Byte (N-1) – 8 bits	47	Acknowledge
....	Acknowledge from slave	48:55	Data byte from slave – 8 bits
....	Data Byte N – 8 bits	56	Acknowledge
....	Acknowledge from slave	Data bytes from slave/Acknowledge
....	Stop	Data byte N from slave – 8 bits
		Not Acknowledge
		Stop

Table 4. Byte Read and Byte Write Protocol

Byte Write Protocol		Byte Read Protocol	
Bit	Description	Bit	Description
1	Start	1	Start
2:8	Slave address – 7 bits	2:8	Slave address – 7 bits
9	Write = 0	9	Write = 0
10	Acknowledge from slave	10	Acknowledge from slave
11:18	Command Code – 8 bits '1xxxxxx' stands for byte operation, bits[6:0] of the command code represents the offset of the byte to be accessed	11:18	Command Code – 8 bits '1xxxxxx' stands for byte operation, bits[6:0] of the command code represents the offset of the byte to be accessed
19	Acknowledge from slave	19	Acknowledge from slave
20:27	Data byte from master – 8 bits	20	Repeat start
28	Acknowledge from slave	21:27	Slave address – 7 bits
29	Stop	28	Read = 1
		29	Acknowledge from slave
		30:37	Data byte from slave – 8 bits
		38	Not Acknowledge
		39	Stop

Serial Control Registers

Byte 0: Frequency and Spread Spectrum Control Register

Bit	@Pup	Pin#	Name	Description
7	Inactive = 0			Write Disable (write once). A 1 written to this bit after a 1 has been written to Byte0 bit0 will permanently disable modification of all configuration registers until the part has been powered off. Once the clock generator has been Write Disabled, the SMBus controller should still accept and acknowledge subsequent write cycles but it should not modify any of the registers.
6	0			For Test, always program to '0'
5	1	12	PCI33_7	Enable (1 = Enabled, 0 = Disabled)
4	FS3 pin	31	FS3	corresponds to Frequency Selection. See <i>Table 1</i> .
3	FS2 pin	45	FS2	corresponds to Frequency Selection. See <i>Table 1</i> .
2	FS1 pin	48	FS1	corresponds to Frequency Selection. See <i>Table 1</i> .
1	FS0 pin	1	FS0	corresponds to Frequency Selection. See <i>Table 1</i> .
0	Inactive = 0			Write Enable. A 1 written to this bit after power-up will enable modification of all configuration registers and subsequent 0's written to this bit will disable modification of all configuration except this single bit. Note that block write transactions to the interface will complete, however unless the interface has been previously unlocked, the writes will have no effect. The effect of writing this bit does not take effect until the subsequent block write command.

Byte 1: PCI Clock Control Register

Bit	@Pup	Pin#	Name	Description
7	1	23	PCI33_F	Enable (1 = Enabled, 0 = Disabled)
6	1	24	PCI33_6	Enable (1 = Enabled, 0 = Disabled)
5	1	22	PCI33_5	Enable (1 = Enabled, 0 = Disabled)
4	1	21	PCI33_4	Enable (1 = Enabled, 0 = Disabled)
3	1	18	PCI33_3	Enable (1 = Enabled, 0 = Disabled)
2	1	17	PCI33_2	Enable (1 = Enabled, 0 = Disabled)
1	1	14	PCI33_1	Enable (1 = Enabled, 0 = Disabled)
0	1	13	PCI33_0	Enable (1 = Enabled, 0 = Disabled)

Byte 2: USB, 24–48MHz, REF(0:2) Control Register

Bit	@Pup	Pin #	Name	Description
7	active = 1	37, 36	CPUT/C(1)	CPUT/C(1) shutdown. This bit can be optionally used to disable the CPUT/C(1) clock pair. During shutdown, CPUT = low and CPUC = high
6	active = 1	41, 40	CPUT/C(0)	CPUT/C(0) shutdown. This bit can be optionally used to disable the CPUT/C(0) clock pair. During shutdown, CPUT = low and CPUC = high
5	active = 1	45	REF2	Enable (1 = Enabled, 0 = Disabled)
4	active = 1	48	REF1	Enable (1 = Enabled, 0 = Disabled)
3	active = 1	1	REF0	Enable (1 = Enabled, 0 = Disabled)
2	active = 1	28	24_48MHz	Enable (1 = Enabled, 0 = Disabled)
1	active = 1	31	USB	Enable (1 = Enabled, 0 = Disabled)
0	0			For Test, always program to '0'

Byte 3: PCI Clock Free Running Select Control Register

Bit	@Pup	Pin #	Name	Description
7	Inactive = 0			PCI_DRV 0 = Low Strength 1 = High Strength
6	Inactive = 0			PCI33_HT66 Drive Strength 0 = Low Strength 1 = High Strength
5	Inactive = 0	22	PCI5	Free running enable (10 = Free running, 0 = Disabled)
4	Inactive = 0	21	PCI4	Free running enable (1 = Free running, 0 = Disabled)
3	Inactive = 0	18	PCI3	Free running enable (1 = Free running, 0 = Disabled)
2	1	11	PCI33_HT66_3	Enable (1 = Enabled, 0 = Disabled)
1	1	8	PCI33_HT66_2	Enable (1 = Enabled, 0 = Disabled)
0	1	7	PCI33_HT66_1	Enable (1 = Enabled, 0 = Disabled)

Byte 4: Pin Latched/Real-time State

Bit	@Pup	Pin#	Name	Description
7	1	6	PCI33_HT66_0	Enable (1 = Enabled, 0 = Disabled)
6	HW		24_48MHz/SEL#	Pin power-up latched state
5	0		Reserved	For Test, always program to '0'
4	1		SSEN	Spread Spectrum enable (0 = disable, 1 = enable). This bit provides a SW programmable control for spread spectrum clocking.
3	FS3 pin	31	FS3	Power-up latched state
2	FS2 pin	45	FS2	Power-up latched state
1	FS1 pin	48	FS1	Power-up latched state
0	FS0 pin	1	FS0	Power-up latched state

Byte 5: SSCG, Dial-a-Skew™, and Dial-a-Ratio™ Register

Bit	@Pup	Description																																				
7	0	Spread Spectrum Selection: <table border="1"> <thead> <tr> <th>bit7</th> <th>bit6</th> <th>bit5</th> <th>% Spread</th> </tr> </thead> <tbody> <tr> <td>0</td> <td>0</td> <td>0</td> <td>-1.5</td> </tr> <tr> <td>0</td> <td>0</td> <td>1</td> <td>-1.0</td> </tr> <tr> <td>0</td> <td>1</td> <td>0</td> <td>-0.7</td> </tr> <tr> <td>0</td> <td>1</td> <td>1</td> <td>-0.5 (default)</td> </tr> <tr> <td>1</td> <td>0</td> <td>0</td> <td>±0.75</td> </tr> <tr> <td>1</td> <td>0</td> <td>1</td> <td>±0.50</td> </tr> <tr> <td>1</td> <td>1</td> <td>0</td> <td>±0.35</td> </tr> <tr> <td>1</td> <td>1</td> <td>1</td> <td>±0.25</td> </tr> </tbody> </table>	bit7	bit6	bit5	% Spread	0	0	0	-1.5	0	0	1	-1.0	0	1	0	-0.7	0	1	1	-0.5 (default)	1	0	0	±0.75	1	0	1	±0.50	1	1	0	±0.35	1	1	1	±0.25
bit7	bit6		bit5	% Spread																																		
0	0		0	-1.5																																		
0	0		1	-1.0																																		
0	1		0	-0.7																																		
0	1		1	-0.5 (default)																																		
1	0		0	±0.75																																		
1	0		1	±0.50																																		
1	1	0	±0.35																																			
1	1	1	±0.25																																			
6	1																																					
5	1																																					

Byte 5: SSCG, Dial-a-Skew™, and Dial-a-Ratio™ Register (continued)

Bit	@Pup	Description		
4	0	HT66 Frequency Fractional Aligner: These bits determine the HT66 fixed frequency when the HT66 Output Frequency Selection bit is set. It does not incorporate spread spectrum.		
3	0	Fract_Align PCI_HT PCI		
2	0	bit[4:0]	(MHz)	(MHz)
1	0	00000	Off	Off (default)
0	0	00001	66.5	33.2
		00010	67.5	33.7
		00011	68.5	34.3
		00100	69.5	34.8
		00101	70.6	35.3
		00110	71.6	35.8
		00111	72.6	36.3
		01000	73.6	36.8
		01001	74.7	37.3
		01010	75.7	37.8
		01011	76.7	38.4
		01100	77.7	38.9
		01101	78.7	39.4
		01110	79.8	39.9
		01111	80.8	40.4
		10000	81.8	40.9
10001	82.8	41.4		
10010	83.9	41.9		
10011	84.9	42.4		
10100	85.9	43.0		
10101	86.9	43.5		
10110	88.0	44.0		
10111	89.0	44.5		
11000	90.0	45.0		
11001	91.0	45.5		
11010	92.0	46.0		
11011	93.1	46.5		
11100	94.1	47.0		
11101	95.1	47.6		
11110	96.1	48.1		
11111	97.2	48.6		

Byte 6: Watchdog Control Register

Bit	@Pup	Name	Description
7	0	HT66 Output Frequency Selection	HT66 Output Frequency Selection: 0: Set according to Frequency Selection Table 1: Set according to Fractional Aligner Table
6	0	Pin 44 Mode Select	Pin 44 Mode Select: 0 = Pin 12 is the output pin as SRESET# signal. 1 = Pin 12 is the input pin which functions as a PD# signal.
5	0	Frequency Reversion	Frequency Reversion: This bit allows setting the Revert Frequency once the system is rebooted due to Watchdog time out only. 0 = Selects frequency of existing H/W setting 1 = Selects frequency of the second to last S/W setting. (the software setting prior to the one that caused a system reboot).
4	0	WD Time-out	WD Time-out: This bit is set to "1" when the Watchdog times out. It is reset to "0" when the system clears the WD time stamps (WD3:0).

Byte 6: Watchdog Control Register (continued)

Bit	@Pup	Name	Description
3	0	WD3	This bit allows the selection of the time stamp for the Watchdog timer. After a Watchdog time-out, the frequency will revert to the original frequency.
2	0	WD2	
1	0	WD1	
0	0	WD0	WD3 WDO
			0 0 0 0 Off (default)
			0 0 0 1 1 second
			0 0 1 0 2 seconds
			0 0 1 1 3 seconds
			0 1 0 0 4 seconds
			0 1 0 1 5 seconds
			0 1 1 0 6 seconds
			0 1 1 1 7 seconds
			1 0 0 0 8 seconds
			1 0 0 1 9 seconds
			1 0 1 0 10 seconds
			1 0 1 1 11 seconds
			1 1 0 0 12 seconds
			1 1 0 1 13 seconds
1 1 1 0 14 seconds			
1 1 1 1 15 seconds			

Byte 7: Clock Vendor ID

Bit	@Pup	Description
7	0	Revision ID[1]
6	1	Revision ID[0]
5	0	Device ID[9]
4	1	Device ID[8]
3	1	Vendor ID[3]
2	0	Vendor ID[2]
1	0	Vendor ID[1]
0	0	Vendor ID[0]

Byte 8: Device ID

Bit	@Pup	Description
7	0	Device ID
6	1	Device ID
5	0	Device ID
4	0	Device ID
3	1	Device ID
2	0	Device ID
1	1	Device ID
0	1	Device ID

Byte 9: Dial-a-Frequency Control Register N

Bit	@Pup	Description
7	0	ATPG Pulse

Byte 9: Dial-a-Frequency Control Register N (continued)

Bit	@Pup	Description
6	N6	These bits are for programming the PLL's internal N register. This access allows the user to modify the CPU frequency with great accuracy. All other synchronous clocks (clocks that are generated from the same PLL, such as PCI, remain at their existing ratios relative to the CPU clock.
5	N5	
4	N4	
3	N3	
2	N2	
1	N1	
0	N0	

Byte 10: Dial-a-Frequency Control Register M

Bit	@Pup	Description
7	0	ATPG Mode (default = 0)
6	M5	These bits are for programming the PLL's internal M register. This access allows the user to modify the CPU frequency with great accuracy. All other synchronous clocks (clocks that are generated from the same PLL, such as PCI, remain at their existing ratios relative to the CPU clock.
5	M4	
4	M3	
3	M2	
2	M1	
1	M0	
0	DAFEN	When this bit = 1, it enables the Dial-a-Frequency N and M bits to be multiplexed into the internal N and M registers. When this bit = 0, the ROM based N and M values are loading into the internal N and M registers.

Byte 11:

Bit	@Pup	Pin #	Name	Description
7	0			For Test, ALWAYS program to '0'
6	HW	7	PCI33HT66SEL1#	PCI33/HT66 Mode Select 1 Power-up Latched State of PCI33HT66SEL1# Mode Select 1 (read only).
5	HW	6	PCI33HT66SEL0#	PCI33/HT66 Mode Select 0 Power-up Latched State of PCI33HT66SEL0# Mode Select 0 (read only).
4	0			Reserved Set = 0
3	0			Reserved Set = 0
2	0			Reserved Set = 0
1	0			Reserved Set = 0
0	0			Reserved Set = 0

System Self-Recovery Clock Management

This feature is designed to allow the system designer to change frequency while the system is running and reboot the operation of the system in case of a hang up due to the frequency change.

When the system sends an SMBus command requesting a frequency change through the Dial-a-Frequency Control Registers, it must have previously sent a command to the Watchdog Timer to select which time out stamp the Watchdog must perform, otherwise the System Self-Recovery feature will not be applicable. Consequently, this device will change frequency and then the Watchdog timer starts timing. Meanwhile, the system BIOS is running its operation with the

new frequency. If this device receives a new SMBus command to clear the bits originally programmed in Watchdog Timer bits (reprogram to 0000) before the Watchdog times out, then this device will keep operating in its normal condition with the new selected frequency.

The Watchdog timer will also be triggered if you program the software frequency select bits (FSEL) to a new frequency selection. If the Watchdog times out before the new SMBus reprograms the Watchdog Timer bits to (0000), then this device will send a low system reset pulse, on SRESET#, and changes WD Time-out bit to "1."

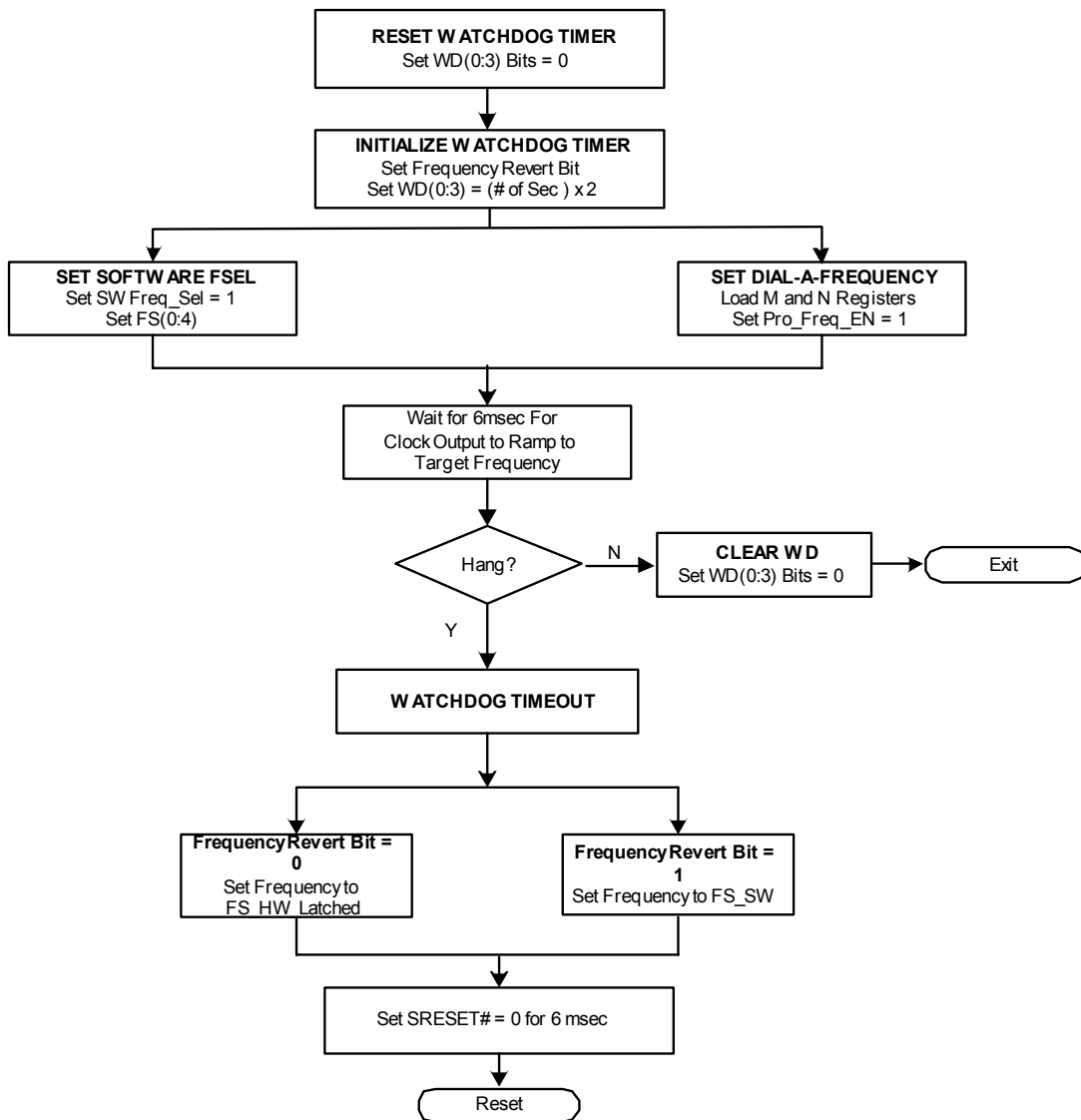

Absolute Maximum Ratings

Parameter	Description	Conditions	Min.	Max.	Unit
V_{DD}, V_{DDA}, V_{DDF}	Supply Voltage	Non-functional	-0.5	4.6	V
V_{IN}	Input Voltage	Functional	-0.5	$V_{DD} + 0.5$	V
T_S	Storage Temperature	Non-functional	-65	+150	°C
T_J	Temperature, Junction	Functional		+150	°C
θ_{JC}	Dissipation, Junction to Case	Mil-Spec 883E Method 1012.1	32.78		°C/W
θ_{JA}	Dissipation, Junction to Ambient	JEDEC (JESD 51)	73.61		°C/W
ESD_h	ESD Protection (Human Body Model)	MIL-STD-883, Method 3015	> 2,000		V
UI-94	Flammability Rating	V-0 @1/8 in.		10	ppm
MSL	Moisture Sensitivity Level		1		

Recommended Operating Conditions

Parameter	Description	Min.	Typ.	Max.	Unit
V_{DD}, V_{DDA}, V_{DDF}	Supply Voltage	3.135	3.3	3.465	V
T_A	Operating Temperature, Ambient	0		70	°C
F_{XIN}	Input Frequency (Crystal or Reference)	10	14.318	16	MHz

SCLK and SDATA Input Electrical Characteristics (5V-tolerant)

Parameter	Description	Conditions	Min.	Typ.	Max.	Unit
V_{IL}	Input Low Voltage		$V_{SS} - 0.5$		0.8	V
V_{IH}	Input High Voltage		2.0		$V_{DD} + 0.3$	V
I_{IL}, I_{IH}	Input High/Low Current	$0 < V_{IN} < V_{DD}$			±5	µA
V_{OL}	Output High Voltage	$I_{OL} = 1.75 \text{ mA}$	$V_{SS} - 0.3$		0.4	V
I_{OL}	Output Low Current	$V_O = 0.8V$	2		6	mA

DC Electrical Specifications (All outputs loaded)

Parameter	Description	Conditions	Min.	Typ.	Max.	Unit
V_{IL}	Input Low Voltage		$V_{SS} - 0.5$		0.8	V
V_{IH}	Input High Voltage		2.0		$V_{DD} + 0.5$	V
I_{IL}	Input Low Current	@ $V_{IL} = V_{SS}$, except PU and PD			-5	µA
I_{IH}	Input High Current	@ $V_{IH} = V_{DD}$, except PU and PD			5	µA
I_{TSL}	Three-state Leakage Current				10	µA
$I_{DD3.3V}$	Dynamic Supply Current	CPU(0:1) @ 200 MHz		250		mA
$I_{PD3.3V}$	Power-down Supply Current				2	mA
C_{IN}	Input Pin Capacitance	Except XIN and XOUT			5	pF
C_{OUT}	Output Pin Capacitance				6	pF
L_{PIN}	Pin Inductance				7	nH
C_{XTAL}	Crystal Pin Capacitance	Measured from Pin to Ground.	27	36	45	pF
V_{BIAS}	Crystal DC Bias Voltage		$0.3V_{DD}$	$V_{DD}/2$	$0.7V_{DD}$	V

AC Electrical Specifications

Parameter	Description	Test Condition	PCI133_HT66 = 66MHz			
			Min.	Typ.	Max.	Unit
Hammer CPU						
T _R	Output Rise Edge Rate	Measured @ the Hammer test load using VO _{CM} ± 400 mV, 0.850V to 1.650V	2		7	V/ns
T _F	Output Fall Edge Rate	Measured @ the Hammer test load using VO _{CM} ± 400 mV, 1.650V to 0.850V	2		7	V/ns
V _{DIFF}	Differential Voltage	Measured @ the Hammer test load (single-ended)	0.4	1.25	2.3	V
Δ _{DIFF}	Change in V _{DIFF_DC} Magnitude	Measured @ the Hammer test load (single-ended)	-150		150	mV
V _{CM}	Common Mode Voltage	Measured @ the Hammer test load (single-ended)	1.05	1.25	1.45	V
ΔV _{CM}	Change in V _{CM}	Measured @ the Hammer test load (single-ended)	-200		200	mV
T _{DC}	Duty Cycle	Measured at V _{OX}	45	50	53	%
T _{CYC}	Jitter, Cycle to Cycle	Measured at V _{OX}	0	100	200	ps
T _{ACCUM}	Jitter, Accumulated	Measured at V _{OX}	-1000		1000	ps
T _{FS}	Frequency Stabilization from Power-up	Measure from full supply voltage	0		3	ms
R _{ON}	Output Impedance	Average value during switching transition	15	35	55	W
PCI/HyperTransport Clock Outputs						
V _{OL}	Output Low Voltage	I _{OL} = 9.0 mA			0.4	V
V _{OH}	Output High Voltage	I _{OH} = -12.0 mA	2.4			V
I _{OL}	Output Low Current	V _O = 0.8V	10			mA
I _{OH}	Output High Current	V _O = 2.0V			-15	mA
F ₃₃	Frequency Actual			33.33		MHz
F ₆₆				66.67		MHz
T _R	Output Rise Edge Rate	Measured from 20% to 60%	0.5		4	V/ns
T _F	Output Fall Edge Rate	Measured from 60% to 20%	0.5		4	V/ns
T _{DC}	Duty Cycle	Measured at 1.5V	45		55	%
T _{CCJ}	Cycle-to-Cycle Jitter	Measured at 1.5V	0		400	ps
T _{LTJ}	Long Term Jitter	Measured at 1.5V	-1000		1000	ps
REF(0:2) Clock Outputs						
V _{OL}	Output Low Voltage	I _{OL} = 9.0 mA			0.4	V
V _{OH}	Output High Voltage	I _{OH} = -12.0 mA	2.4			V
I _{OL}	Output Low Current	V _O = 0.8V	16			mA
I _{OH}	Output High Current	V _O = 2.0V			-22	mA
F	Frequency, Actual			14.318		MHz
T _R	Output Rise Edge Rate	Measured from 20% to 60%	0.5		2	V/ns
T _F	Output Fall Edge Rate	Measured from 60% to 20%	0.5		2	V/ns
T _{DC}	Duty Cycle	Measured at 1.5V	45		55	%
T _{CCJ}	Cycle-to-Cycle Jitter	Measured at 1.5V	0	500	1000	ps
T _{LTJ}	Long-term Jitter	Measured at 1.5V	-1000		1000	ps
T _{FS}	Frequency Stabilization from Power-up	Measure from full supply voltage	0		3	mS
R _{ON}	Output Impedance	Average value during switching transition	20	24	60	W

AC Electrical Specifications (continued)

Parameter	Description	Test Condition	PCI133_HT66 = 66MHz			
			Min.	Typ.	Max.	Unit
USB, 24_48 Clock Outputs						
V _{OL}	Output Low Voltage	I _{OL} = 9.0 mA			0.4	V
V _{OH}	Output High Voltage	I _{OH} = -12.0 mA	2.4			V
I _{OL}	Output Low Current	V _O = 0.8V	16			mA
I _{OH}	Output High Current	V _O = 2.0V			-22	mA
F ₃₃	Frequency Actual			24.004		MHz
F ₆₆				48.008		MHz
t _R	Output Rise Edge Rate	Measured from 20% to 80%	0.5		2	V/ns
t _F	Output Fall Edge Rate	Measured from 80% to 20%	0.5		2	V/ns
t _D	Duty Cycle	Measured at 1.5V	45		55	%
T _{CCJ}	24_48MHz Cycle-to-Cycle Jitter	Measured at 1.5V	0	250	500	ps
T _{CCJ}	USB Cycle-to-Cycle Jitter	Measured at 1.5V	0		200	ps
T _{LTJ}	Long-term Jitter	Measured at 1.5V	-1000		1000	ps
T _{STABLE}	Frequency Stabilization from Power-up	Measure from full supply voltage	0		3	ms
R _{ON}	Output Impedance	Average value during switching transition	20	24	60	W

Table 6. Skew [2]

Parameter	Description	Conditions	Skew Window	Unit
TSK_CPU_CPU	CPU to CPU skew, time independent	Measured @ crossing points for CPUT rising edges ¹	250	ps
TSK_CPU_PCI33	CPU to PCI33 skew, time independent	Measured @ crossing points for CPUT rising edge and 1.5V PCI clocks	500	ps
TSK_PCI33_PCI33	PCI33 to PCI33 skew, time independent	Measured between rising @ 1.5V	500	ps
TSK_PCI33_HT66	PCI33 to HT66 skew, time independent	Measured between rising @ 1.5V	500	ps
TSK_CPU_HT66	CPU to HT66 skew, time independent	Measured @ crossing points for CPUT rising edge and 1.5V for HyperTransport clocks	500	ps
TSK_HT66_HT66	HT66 to HT66 skew, time independent	Measured between rising @ 1.5V	500	ps
TSK_CPU_CPU	CPU to CPU skew, time variant	Measured @ crossing points for CPUT rising edges	200	ps
TSK_CPU_PCI33	CPU to PCI33 skew, time variant	Measured @ crossing points for CPUT rising edge and 1.5V PCI clocks	200	ps
TSK_PCI33_PCI33	PCI33 to PCI33 skew, time variant	Measured between rising @ 1.5V	200	ps
TSK_PCI33_HT66	PCI33 to HT66 skew, time variant	Measured between rising @ 1.5V	200	ps
TSK_CPU_HT66	CPU to HT66 skew, time variant	Measured @ crossing points for CPUT rising edge and 1.5V for HyperTransport clocks	200	ps
TSK_HT66_HT66	HT66 to HT66 skew, time variant	Measured between rising @ 1.5V	200	ps

Note:

2. All skews in this skew budget are measured from the first referenced signal to the next. Therefore, this skew specifies the maximum SKEW WINDOW between these two signals to be 500 ps whether the CPU crossing leads or lags the PCI clock. This should NOT be interpreted to mean that the PCI33 edge could either be 500 ps before the CPU clock to 500 ps after the clock, thus defining a 1000ps window in which the PCI33 clock edge could fall.

Table 7.

Clock Name	Max Load (in pF) ^[3]
CPU, USB, 24_48MHz, REF	20
PCI33, PCI33_F, PCI33_HT66	30

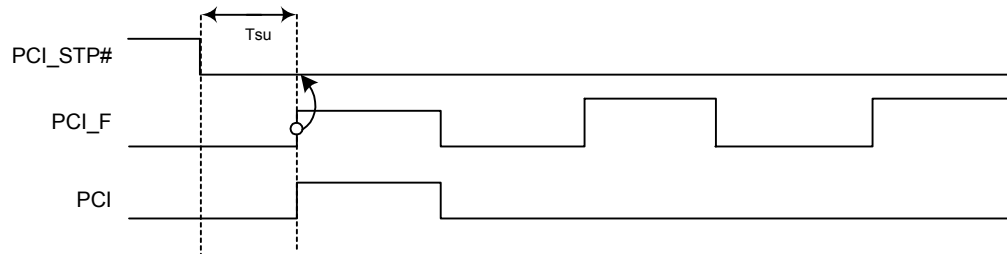
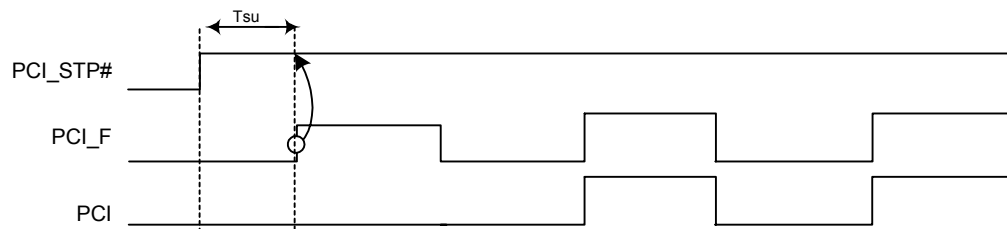
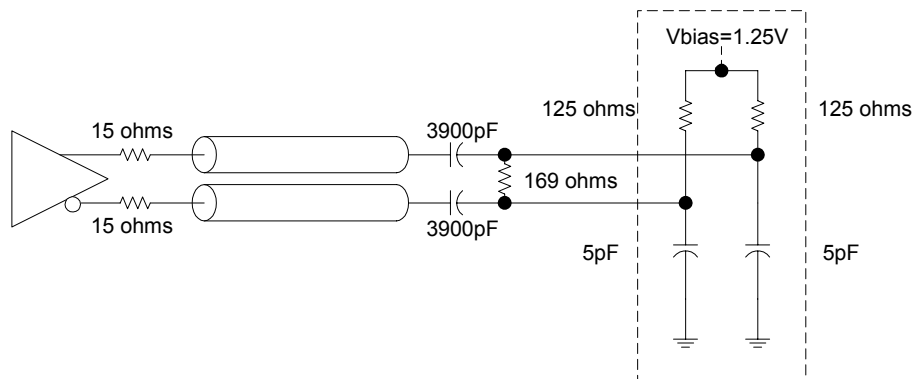
Figure 2. PCISTOP# Assertion Waveform

Figure 3. PCISTOP# Deassertion Waveform

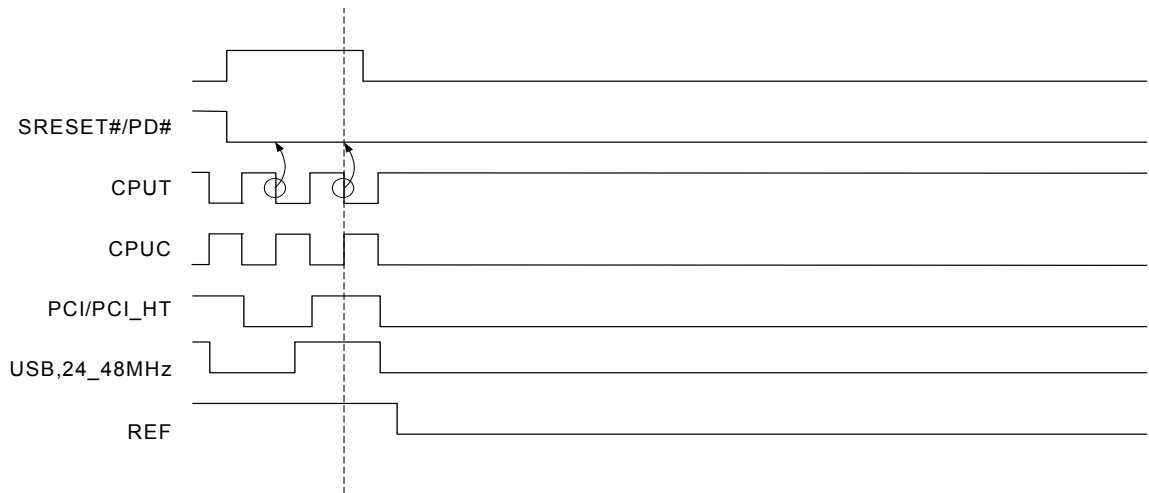
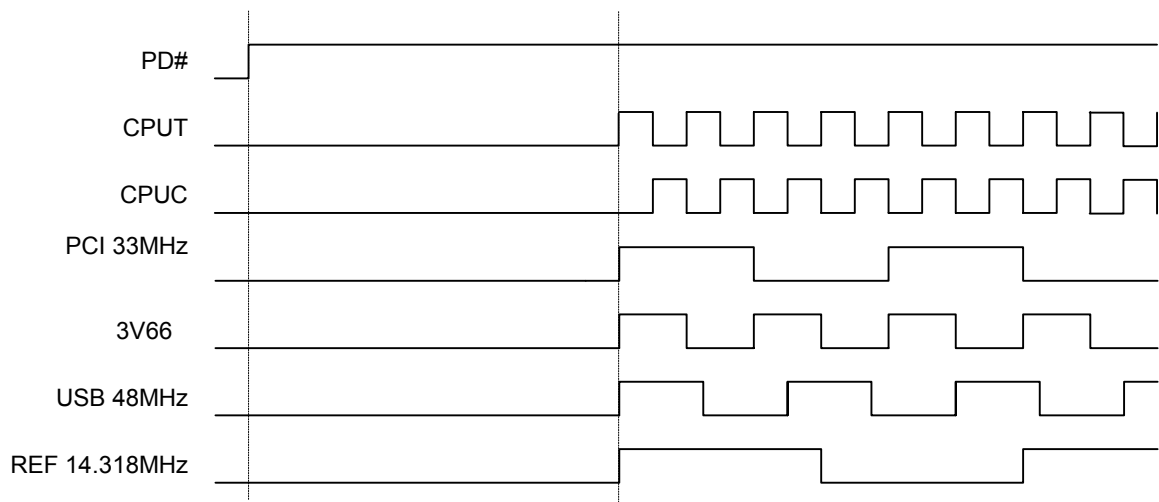
Figure 4. Test Load Configuration
Note:

- The above loads are positioned near each output pin when tested.

Figure 5. PD# Assertion Waveform

Figure 6. PD# Deassertion Waveform
Ordering Information

Part Number	Package Type	Product Flow
CY28331OC	48-pin SSOP	Commercial, 0° to 70°C
CY28331OCT	48-pin SSOP – Tape and Reel	Commercial, 0° to 70°C
Lead-free		
CY28331OXC	48-pin SSOP	Commercial, 0° to 70°C
CY28331OXCT	48-pin SSOP – Tape and Reel	Commercial, 0° to 70°C

Document History Page

Document Title: CY28331 Clock Generator for AMD™ Hammer				
Document Number: 38-07491				
REV.	ECN NO.	Issue Date	Orig. of Change	Description of Change
**	120617	11/11/02	RGL	New Data Sheet
*A	121407	11/12/02	CA	Minor change corrected rev ** on date
*B	125988	04/17/03	RGL	Changed the power up value of the Byte7 bit6 from 0 to 1
*C	131420	12/05/03	RGL/SDR	Changed min. T_R value for PCI/Hypertransport from 1 to 0.5 V/ns Changed min. T_F value for PCI/Hypertransport from 1 to 0.5 V/ns Changed max. T_{CCJ} value for PCI/Hypertransport from 250 to 400 ps
*D	237872	See ECN	RGL	Minor Change: typo error in page one
*E	353939	See ECN	RGL	Added Lead-free devices